

Smart CAT5 Switch 16 IP

Installation Guide



www.minicom.com

International HQ

Jerusalem, Israel
Tel: + 972 2 535 9666
minicom@minicom.com

North American HQ

Linden, NJ, USA
Tel: + 1 908 4862100
info.usa@minicom.com

European HQ

Dübendorf, Switzerland
Tel: + 41 44 823 8000
info.europe@minicom.com

Customer support - support@minicom.com

Table of Contents

1.	Welcome	2
2.	Introduction.....	3
3.	System components	3
4.	System features.....	4
5.	Smart 16 IP front panel	5
6.	The Smart 16 IP rear panel ports	5
7.	Pre-installation instructions	6
8.	Connecting the Smart 16 IP system	6
9.	The RICCs	7
10.	Connecting the CAT5 cables	9
11.	Connecting the KVM console	9
12.	Connecting the power supply	10
13.	Rack mounting the Smart 16 IP.....	10
14.	Rack mounting the RICCs.....	10
15.	Connecting to Ethernet	11
16.	10 Mbps Connection.....	11
17.	100 Mbps Connection	11
18.	Connecting the RS232 Serial cable	11
Appendix A: Pin assignments.....		13
Appendix B: Technical specifications		16
User guide feedback.....		17

1. Welcome

Thank you for buying the Smart CAT5 16 IP system. This system is produced by Minicom Advanced Systems Limited.

Technical precautions

This equipment generates radio frequency energy and if not installed in accordance with the manufacturer's instructions, may cause radio frequency interference.

This equipment complies with Part 15, Subpart J of the FCC rules for a Class A computing device. This equipment also complies with the Class A limits for radio noise emission from digital apparatus set out in the Radio Interference Regulation of the Canadian Department of Communications. These above rules are designed to provide reasonable protection against such interference when operating the equipment in a commercial environment. If operation of this equipment in a residential area causes radio frequency interference, the user, and not Minicom Advanced Systems Limited, will be responsible.

Changes or modifications made to this equipment not expressly approved by Minicom Advanced Systems Limited could void the user's authority to operate the equipment.

Minicom Advanced Systems Limited assumes no responsibility for any errors that appear in this document. Information in this document is subject to change without notice.

No part of this document may be reproduced or transmitted in any form or by any means, electronic or mechanical, for any purpose, without the express written permission of Minicom Advanced Systems Limited.

© 2006 Minicom Advanced Systems Limited. All rights reserved.

Trademarks

All trademarks and registered trademarks are the property of their respective owners.

2. Introduction

The Smart CAT5 Switch 16 IP (Smart 16 IP) from Minicom Advanced Systems redirects local keyboard, mouse and video data to up to 16 remote servers. All data is transmitted via IP.

Smart 16 IP features remote KVM access and control via a LAN or Internet connection. It provides a non-intrusive solution for remote access and control. Remote access and control software runs on the Smart 16 IP embedded processors only and not on the servers, so there is no interference with server operation or impact on network performance.

The Smart 16 IP can also be used in a multi administrator and multi server environment. Cascade the Smart 16 IP to access up to 256 remote servers. The Smart 16 IP combines digital remote KVM access via IP networks with a comprehensive and integrated system management.

3. System components

- 1 Smart 16 IP box
- Cables (illustrated below)
- Remote Interface Connection cables (RICCs) – PS/2, SUN, USB
- CAT5 cables (1.5m provided)
- Null Modem cable
- RS232 Serial cable
- Rack mounts for the Smart 16 IP and the RICCs
- VGA Extender cable
- Marketing & Documentation CD

Figure 1 illustrates a local and remote Administrator managing a 1U server rack with the Smart 16 IP.

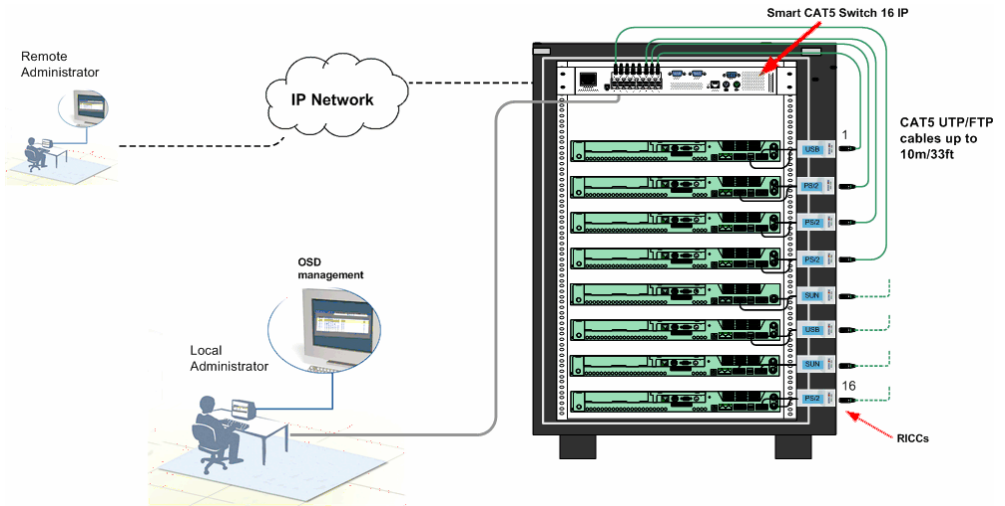

Figure 1 Smart 16 IP usage scenario

4. System features

- KVM (keyboard, video, mouse) access over IP or analogous telephone line.
- Advanced On Screen Display management (including multi-layer security)
- Automatically senses video resolution for best possible screen capture
- High-performance mouse tracking and synchronization
- Operate the system using an On Screen Display (OSD) or Control software or keyboard hotkeys
- Create multi-level cascade arrangements. For example by cascading the Smart 16 IP 16 Port model, connect up to up to 256 computers in the system
- Computers can be placed up to 10m/33ft from the Smart 16 IP
- Multi-platform — supports PS/2, SUN, and USB servers

Smart 16 IP supports PS/2 type keyboards and mice and HD 15 video output. See the pin assignments in Appendix A.

Smart 16 IP automatically detects the current video mode of the console, however manual tuning is recommended to get the best video quality. This results in a screen resolution of 1600x1200 dots with a refresh rate of 60 Hz.

5. Smart 16 IP front panel

Figure 2 illustrates the Smart 16 IP front panel.

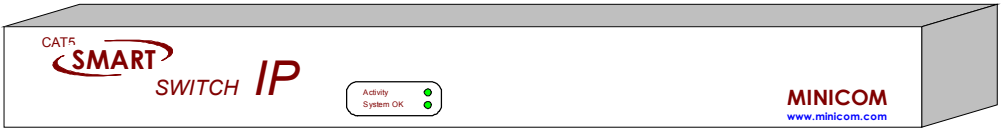

Figure 2 Front panel

The Reset button resets the Smart 16 IP.

The table below explains the functions of the front panel LEDs.

LED	Function
Activity	LED blinks when Network connection is functioning
System OK	LED solid when IP Link system connected and functioning

6. The Smart 16 IP rear panel ports

The figure below illustrates the ports on the Smart 16 IP rear panel.

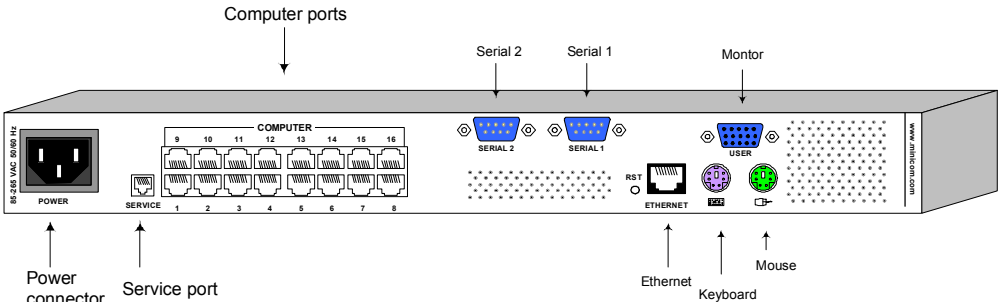

Figure 3 Smart 16 IP ports

You can work locally on the host system by connecting a KVM console to Smart 16 IP rear panel.

Serial 1 port

Serial 1 port is used as follows:

- Initial configuration
- Modem Dial in connection
- IPMI
- Telnet Pass-through
- External power management

Serial 2 port

The Serial 2 port supports the internal and external power options

Ethernet

Connects the Smart 16 IP to an Ethernet network.

7. Pre-installation instructions

- Place cables away from fluorescent lights, air conditioners and other machines that are likely to generate electrical noise
- Switch off all computers
- Ensure that the maximum distance between each computer and the Smart 16 IP, does not exceed 10m/33ft

8. Connecting the Smart 16 IP system

1. Connect the power cord and Ethernet and/or modem connection to the Smart 16 IP.
2. Connect each computer to the Smart 16 IP system using the appropriate RICC and CAT5 cables – explained below.

Figure 4 illustrates the Smart 16 IP system connections with the appropriate RICC connected to a PS/2, SUN and USB computer.

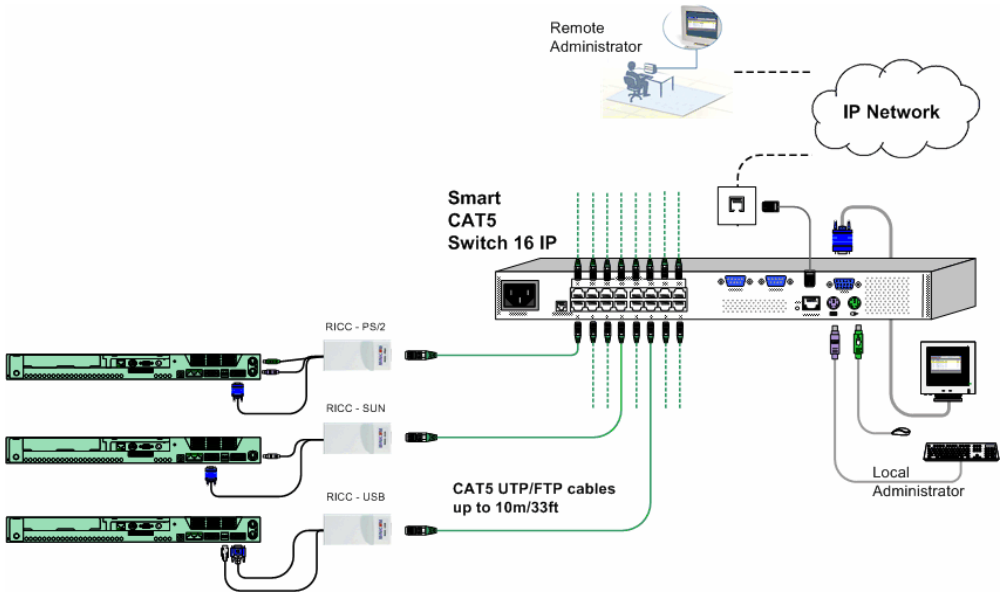

Figure 4 Smart 16 IP system connections

9. The RICCs

The RICCs draw their power from the computer's keyboard port (RICC PS/2, SUN) or from the USB port (RICC USB).

Connecting a PS/2 RICC

Figure 5 illustrates the RICC.

To connect the PS/2 RICC:

1. Connect the Screen connector to the computer's Video card.
2. Connect the Keyboard connector to the computer's Keyboard port.
3. Connect the Mouse connector to the computer's Mouse port.

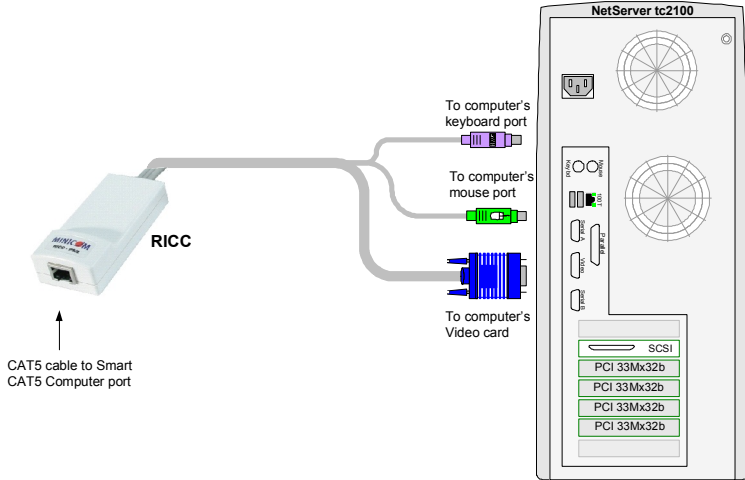

Figure 5 PS/2 RICC

Connecting a SUN RICC

Figure 6 illustrates the SUN RICC and its connections.

To connect the SUN RICC:

1. Connect the Screen connector to the computer's Video card.
2. Connect the Keyboard connector to the computer's Keyboard port.

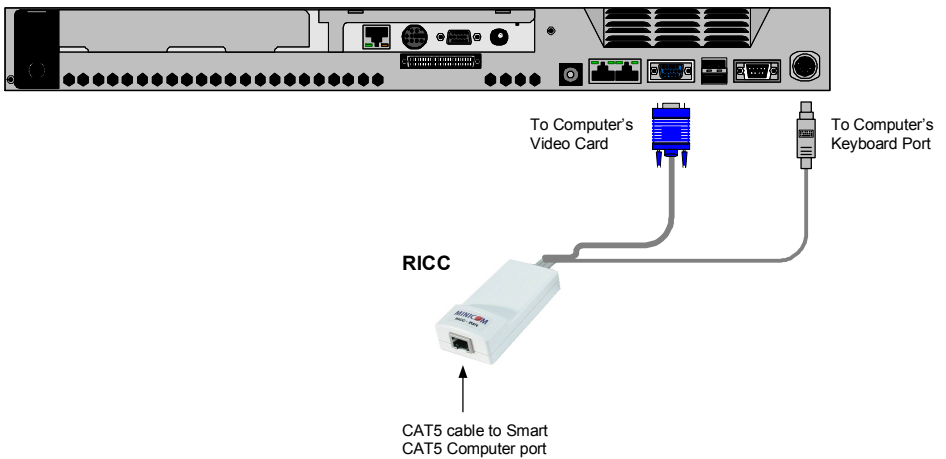

Figure 6 SUN RICC

Connecting a USB RICC

The RICC USB supports Windows 98 SE and later, MAC, SUN and SGI. Figure 7 illustrates the USB RICC and its connections.

To connect the USB RICC:

1. Connect the Screen connector to the computer's Video card.
2. Connect the USB connector to the computer's USB port.

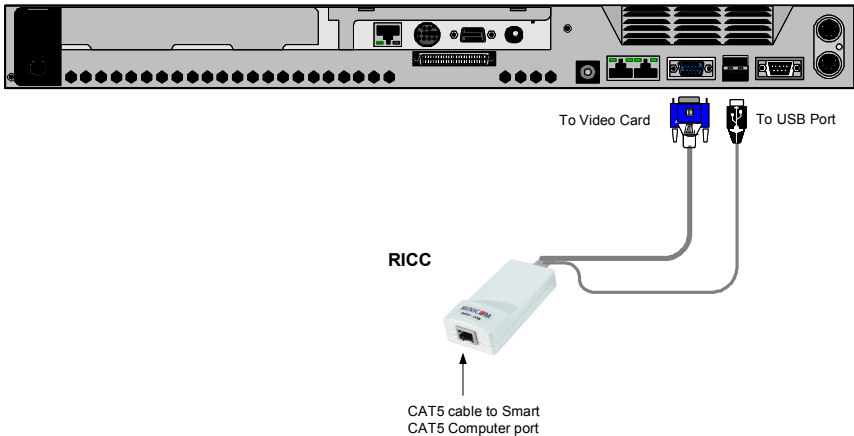

Figure 7 USB RICC

VGA Extender cable

Where the RICC's Screen connector won't reach the computer's Video card, connect the VGA Extender cable to the RICC and then follow the instructions below.

10. Connecting the CAT5 cables

1. Connect one connector to the RICCs RJ45 port.
2. Connect the other connector to one of the Smart 16 IP's Computer ports.
3. Follow the above 2 steps for each computer.

11. Connecting the KVM console

To connect a KVM console to the Smart 16 IP:

1. Connect the monitor's connector to the Smart 16 IP's Monitor port.
2. Connect the keyboard's connector to the Smart 16 IP's Keyboard port.
3. Connect the mouse's connector to the Smart 16 IP's Mouse port.

12. Connecting the power supply

Connect the Smart 16 IP to the power supply using the Power cord provided.

13. Rack mounting the Smart 16 IP

Use the plate and screws provided to mount the Smart 16 IP on a server rack as illustrated below.

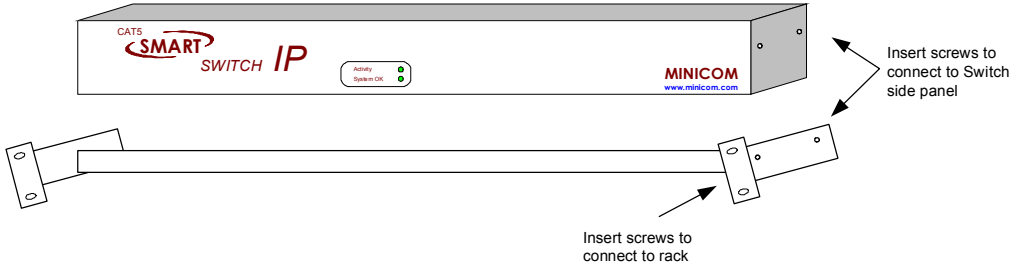

14. Rack mounting the RICCs

You can attach the RICCs to a server rack or computer using the Velcro strips provided. Or connect it using the bracket provided.

The figure below illustrates the bracket.

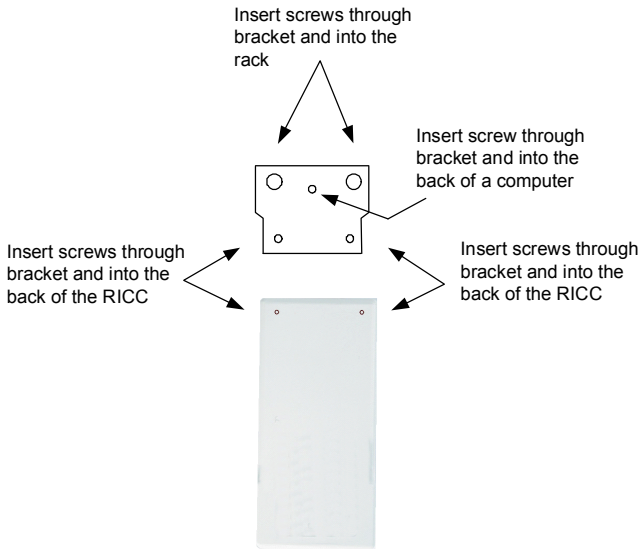

15. Connecting to Ethernet

The Ethernet connector on the Smart 16 IP can be used either for a 100 Mbps 100BASE-TX connection or for a 10 Mbps 10BASE-T connection. The adapter adjusts to the appropriate operation mode automatically.

16. 10 Mbps Connection

For 10BASE-T Ethernet networks, the Fast Ethernet adapter uses Category 3, 4, or 5 UTP/FTP cable. To establish a 10 Mbps connection, the cable must be connected to a 10BASE-T hub. Ensure the cable is wired appropriately for a standard 10BASE-T adapter. Align the RJ-45 plug with the notch on the adapter's connector and insert it into the adapter's connector.

17. 100 Mbps Connection

For 100BASE-TX Fast Ethernet networks, the Smart 16 IP supports Category 5 UTP cabling. To establish a 100 Mbps connection, the cable must be connected to a 100BASE-TX hub.

1. Make sure that the cable is wired appropriately for a standard 100BASE-TX adapter.
2. Align the RJ-45 plug with the notch on the adapter's connector and insert it into the adapter's connector.

Note! The UTP/FTP wire pairs and configuration for 100BASE-TX cable are identical to those for 10BASE-T cable when used with Category 5 UTP/FTP cable.

18. Connecting the RS232 Serial cable

To operate the Smart 16 IP system with the Control software located on the Marketing & Documentation CD, connect the RS232 Serial cable.

To connect the RS232 Serial cable:

1. Connect the cable's RJ11 connector to the Smart 16 IP's Service port. See Appendix A for the Service Connector Pin-out.
2. Connect the cable's DB9F connector to the computer's Serial port.

The figure below illustrates the connections.

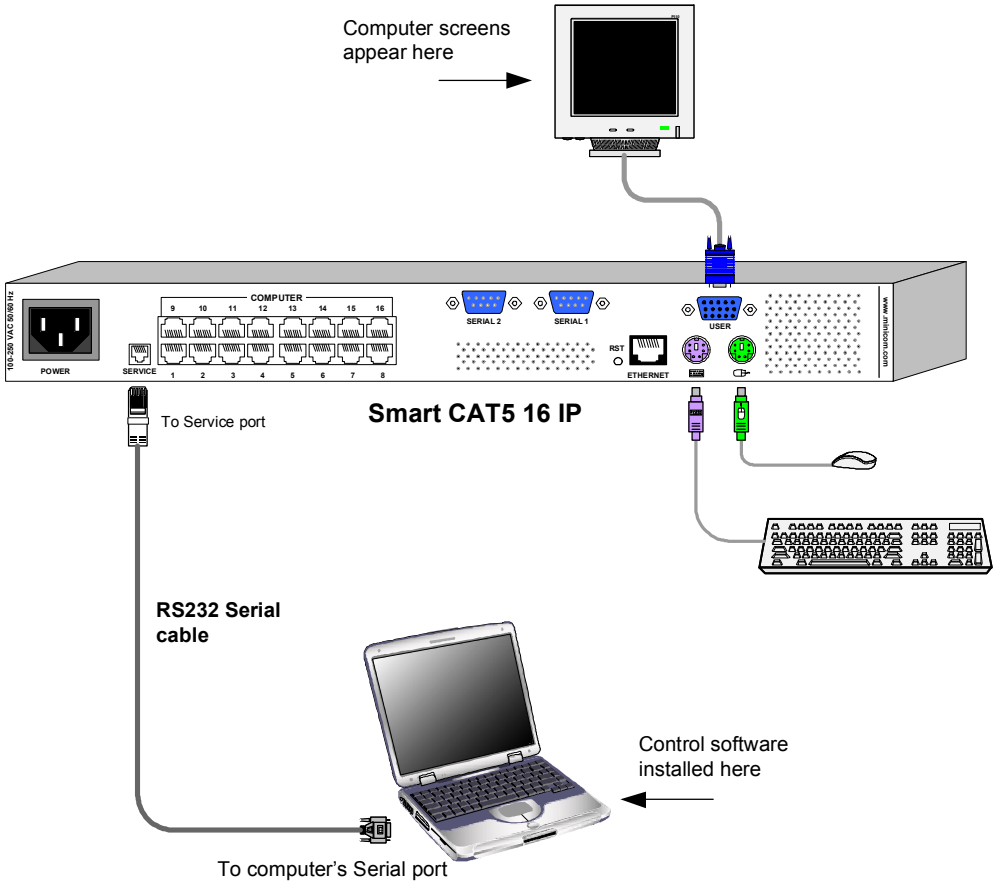
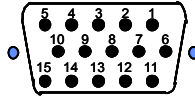

Figure 8 Smart 16 IP with RS232 Serial cable

Appendix A: Pin assignments

VGA HD-15



Pin	Assignment	Pin	Assignment
1	Red	9	5 V
2	Green	10	GND sync
3	Blue	11	Not connected
4	Not connected	12	SDA, DCC, ...
5	GND	13	HSYNC
6	GND red	14	VSYNC
7	GND green	15	DATA CLOCK
8	GND blue		

RS232 Serial cable

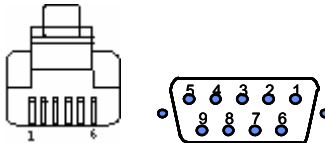

RJ11 Service	Assignment	DB9
1	N/C	-
2	TXD	2
3	RXD	3
4	N/C	-
5	GND	5
6	N/C	-

Keyboard Mouse MiniDIN 6



Pin	Assignment
1	DATA
2	N/C
3	GND
4	VCC
5	CLK
6	N/C

RJ 45 Connector Ethernet

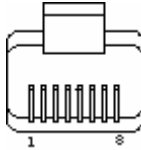

Pin	Assignment	Pin	Assignment
1	TX +	5	Not connected
2	TX -	6	RX -
3	RX +	7	Not connected
4	Not connected	8	Not connected

RJ 45 Connector CAT5 cable

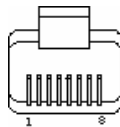

Pin	Assignment	Pin	Assignment
1	Orange	5	Green
2	Orange/White	6	Blue/White
3	Blue	7	Brown
4	Green/White	8	Brown/White

Serial SUB-D 9 Connector 1

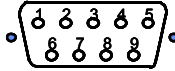

Pin	Assignment	Pin	Assignment
1	DCD	6	DSR
2	RX	7	RTS
3	TX	8	CTS
4	DTR	9	RI
5	GND		

Serial SUB-D 9 Connector 2

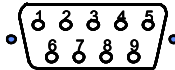

Pin	Assignment	Pin	Assignment
1	DCD	6	DSR, Reset2
2	RX	7	RTS, Power1
3	TX	8	DTS, Power2
4	DTR, Reset1	9	Not connected
5	GND		

Pins 1 and 6 are bridged

Appendix B: Technical specifications

Operating Systems	Host computer: DOS, Novel, Linux, UNIX, Windows 3.1,9X, ME, NT4, 2000, XP, 2003 Server and later. MAC Client computer: Windows 98, ME, 2000, XP and later, Linux, MAC and SUN. Internet browser with full Java support
Resolution	Host: Up to 1600x1200@60Hz Client: Recommended - resolution should be higher than host computer resolution
Switch to server distance	Up to 10m/33ft
System cable	CAT5 UTP/FTP Solid Wire 2x4x24 AWG
Mouse	PS/2, Wheel mouse
Operating temperature	0°C to 40°C / 32° to 104°F
Storage temperature	-40°C to 70°C / -40° to 158°F
Humidity	80% non-condensing relative humidity
Warranty	3 Years

Smart 16 IP Switch	
Dimensions	431mm x 176mm x 41mm / 17" x 6.9" x 1.6"
Weight	2.54Kg / 5.6lbs
Power supply	Internal switching 85-265 VAC 50 / 60 Hz
Connections	
System	RJ45
Serial	RJ11
Local KVM	HDD15/MinDin6/MiniDin6
Line connection	RJ45 – LAN, Autosensing 10/100 Mbit/s
Serial connection	2 x DB9: COM1 for initial configuration and external modem, COM2 for power management only

RICCs	PS/2	USB	SUN
Connections			
VGA	HDD15	HDD15	HDD15
Keyboard/Mouse System	MiniDin6 RJ45	USB RJ45	MiniDin8 RJ45
Power	From computer's Keyboard port	From computer's USB port	From computer's Keyboard port
Weight	107g		
Dimensions	91 x 41 x 24mm / 3.58 x 1.61 x 0.94in		

User guide feedback

Your feedback is very important to help us improve our documentation. Please email any comments to: ug.comments@minicom.com

Please include the following information: Guide name, part number and version number (as appears on the front cover).

Regional Offices

Germany

Kiel

Tel: + 49 431 668 7933

info.germany@minicom.com

France

Vincennes

Tel: + 33 1 49 57 00 00

info.france@minicom.com

Italy

Rome

Tel: + 39 06 8209 7902

info.italy@minicom.com

www.minicom.com

MINICOM
ADVANCED SYSTEMS